

Main Wiring Diagram

Main printboard

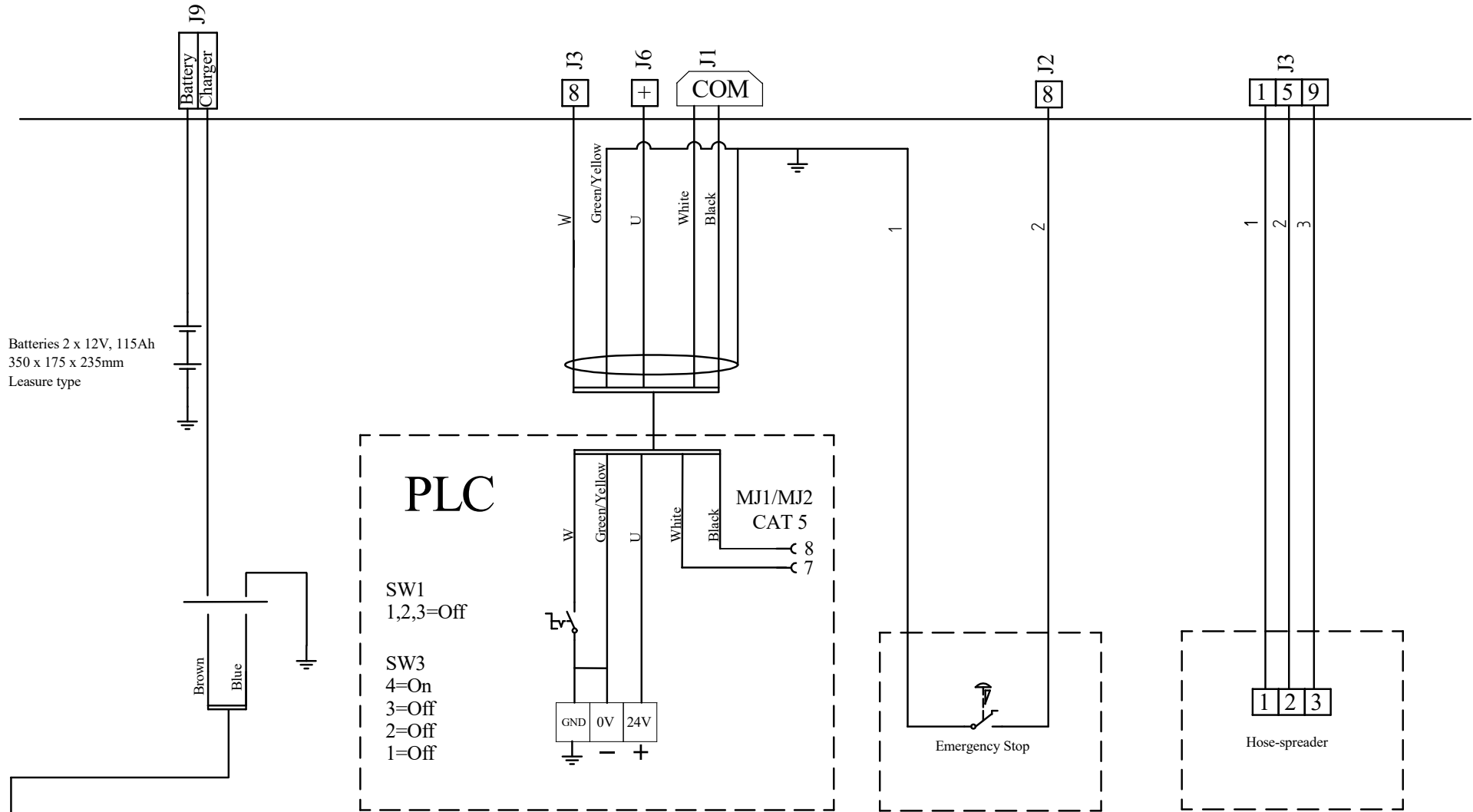

ARBETSNUMMER EVO Cleaner		RITNINGSNUMMER Main	
KONSTRUERAD AV JS		RITAD AV JS	BLAD 1
DATUM 18-02-20		REV. 1	FORTS. 2

NR.	ÄNDRING	SIGN.	DATUM
-----	---------	-------	-------

Chassi Wiring Diagram

Main printboard

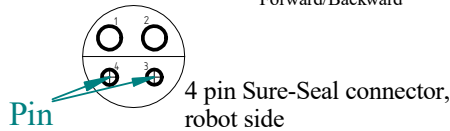
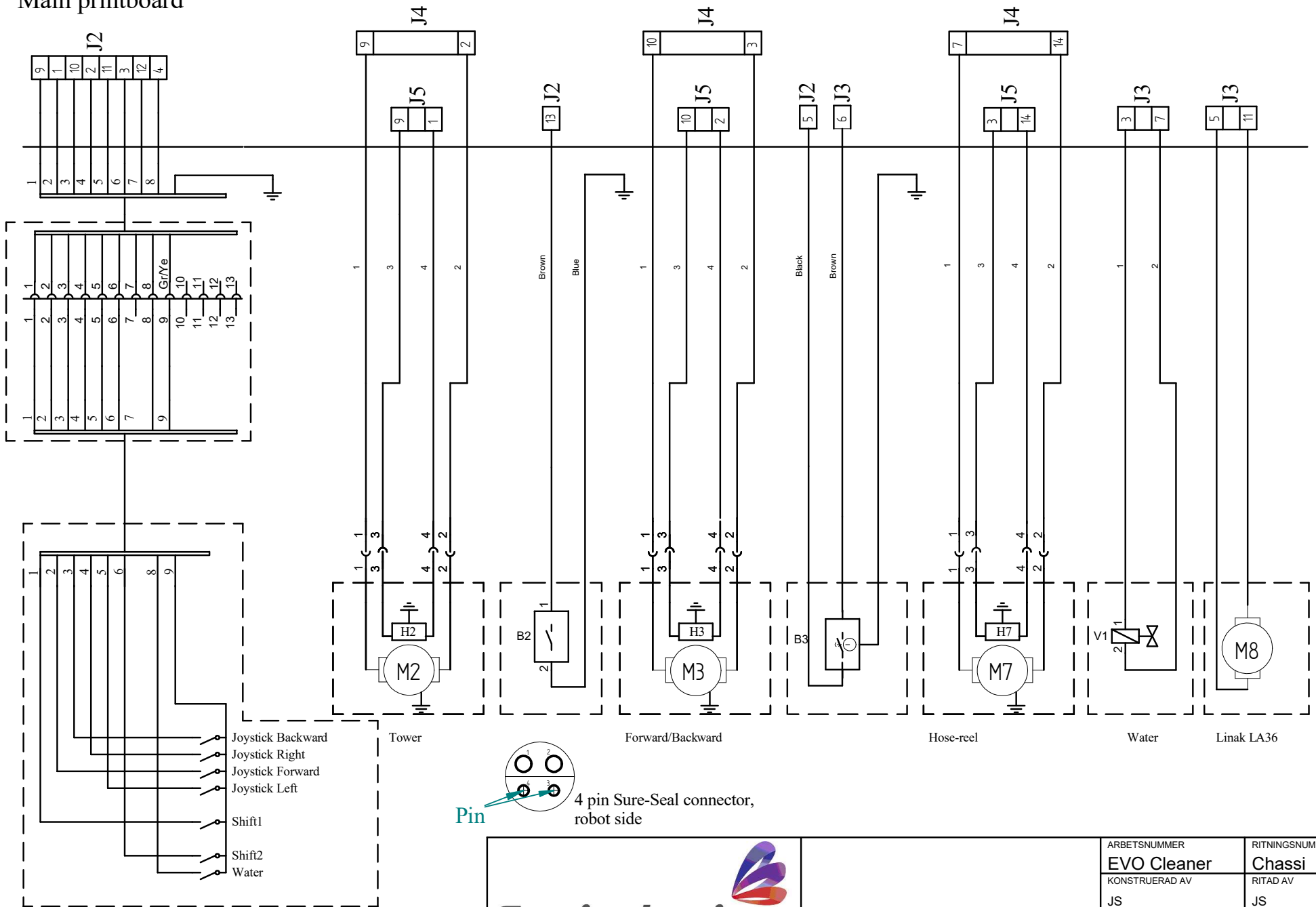

NR.	ÄNDRING	SIGN.	DATUM
-----	---------	-------	-------



ARBETSNUMMER EVO Cleaner		RITNINGNUMMER Chassi	
KONSTRUERAD AV JS		RITAD AV JS	BLAD 2
DATUM 18-02-20		REV.	FORTS. 3

Boom Wiring Diagram

Main printboard

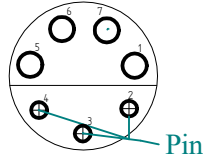
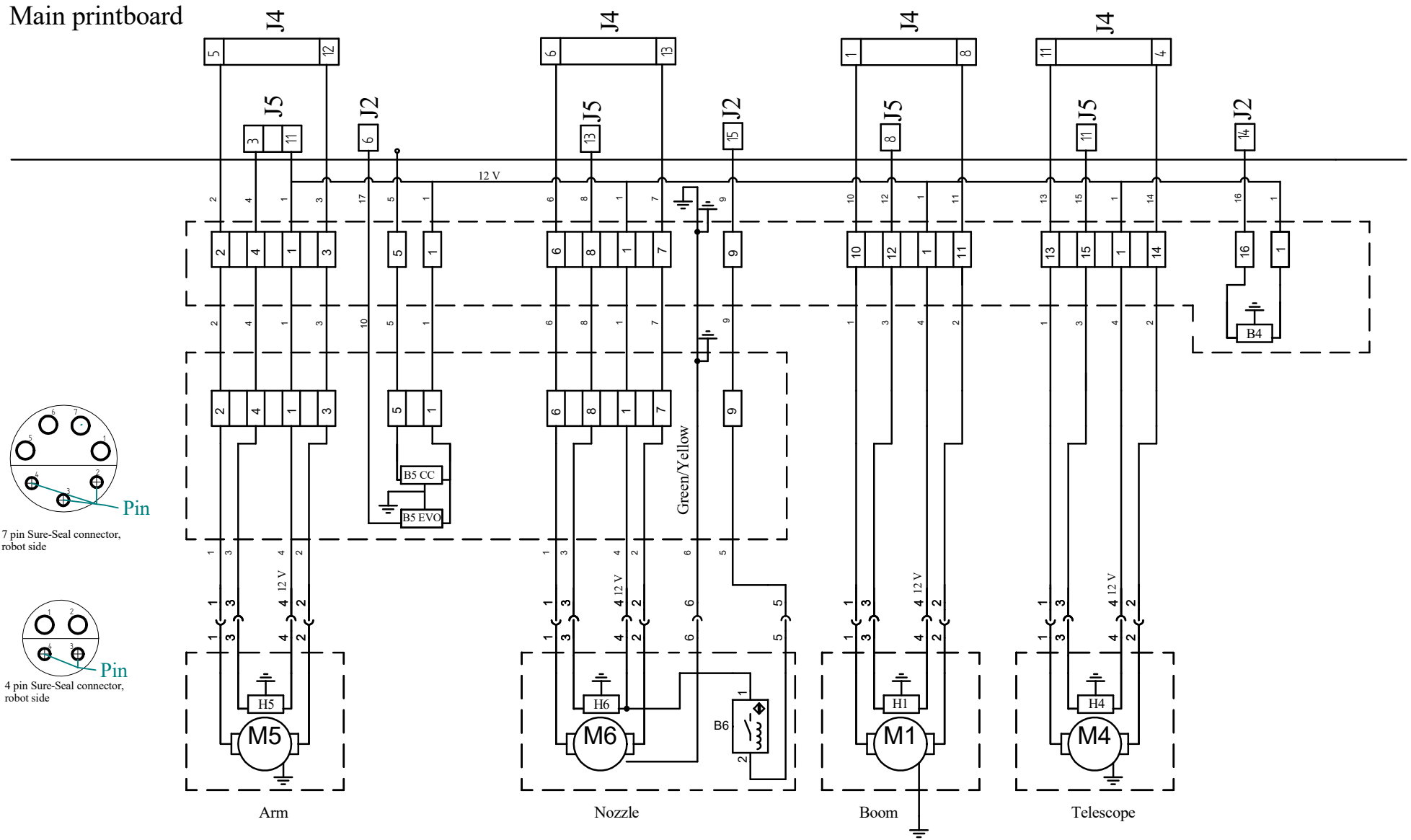

7 pin Sure-Seal connector, robot side

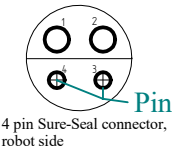

4 pin Sure-Seal connector, robot side

NR.	ÄNDRING	SIGN.	DATUM
-----	---------	-------	-------



ARBETSNUMMER	RITNINGNUMMER	
EVO Cleaner	Boom	
KONSTRUERAD AV	RITAD AV	BLAD
	JS	3
DATUM	REV.	FORTS.
18-02-20		

EVO Connection Instructions

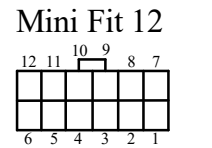
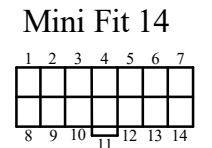
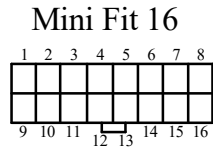
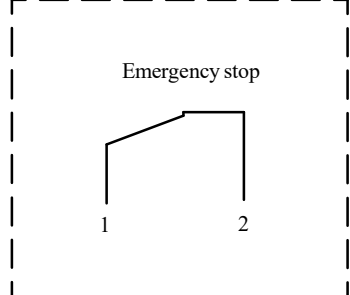
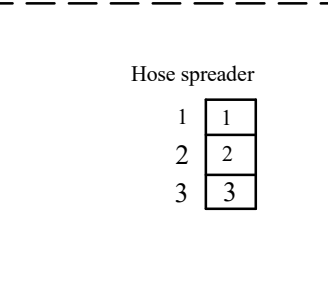
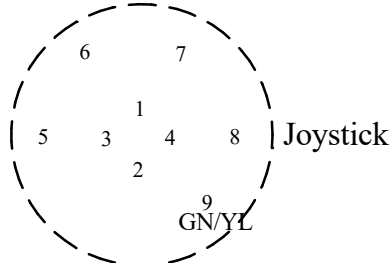
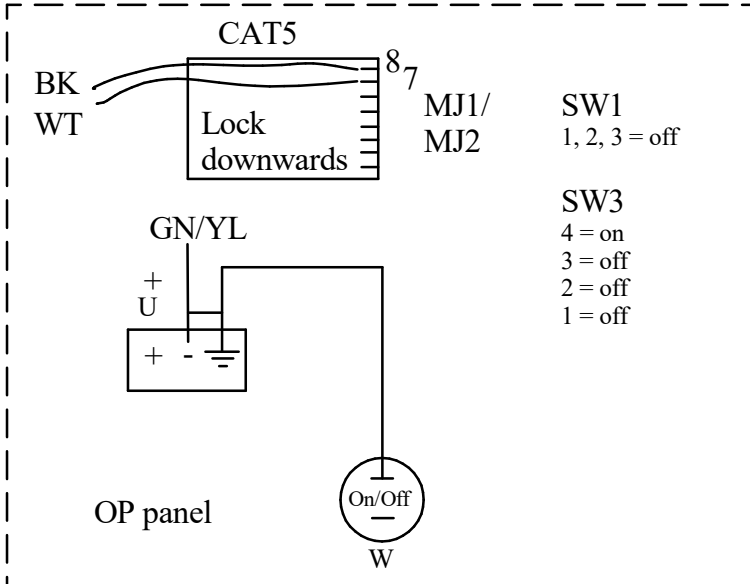
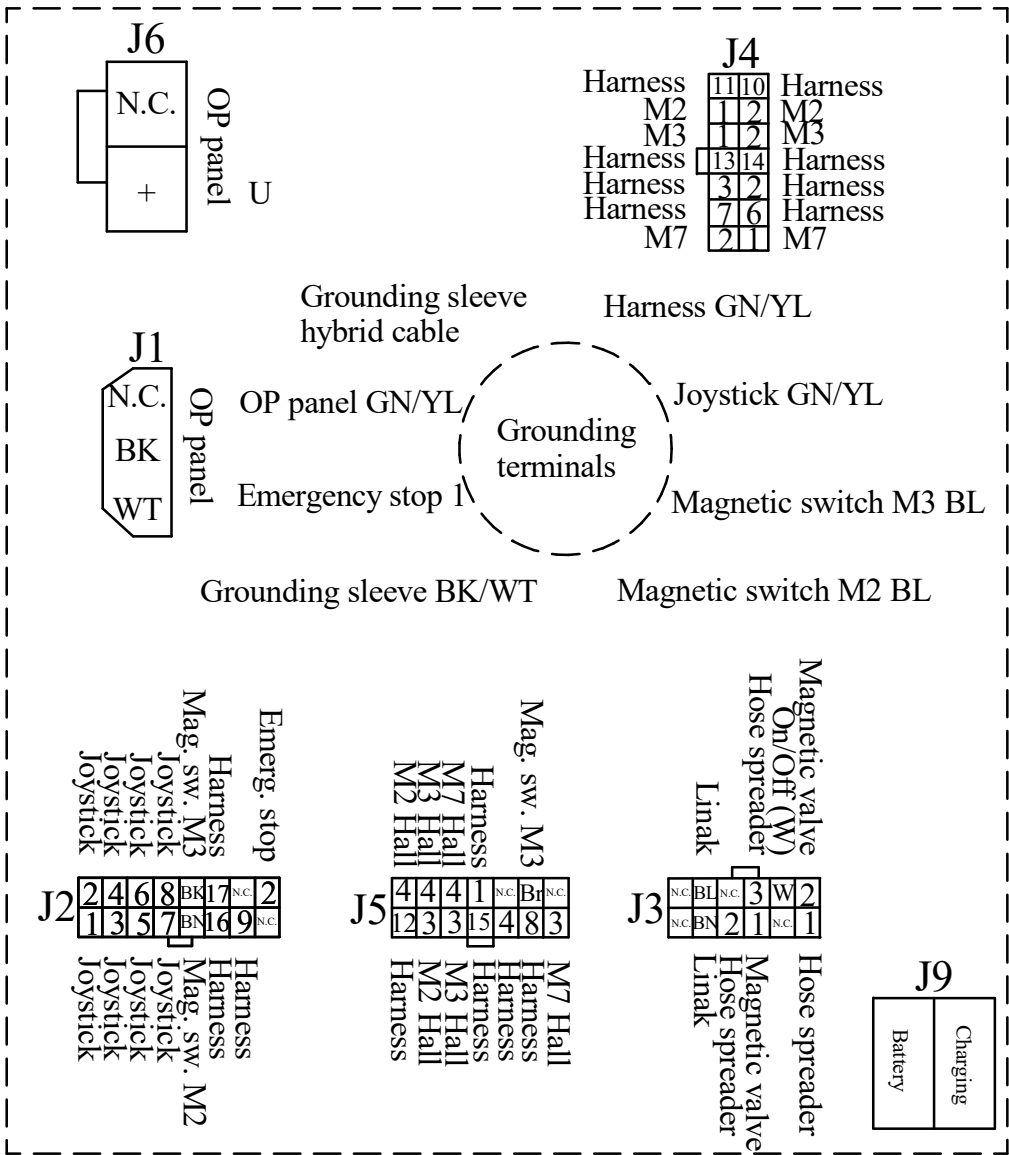

Datum	Ritningsnr	Projekt	Ritad av	Skala	Rev nr	Sida nr
180302		EVO Cleaner	j b			1:1
ENVIROLOGIC AB			Del			
Fyrisvallsg. 24 Tel:018/398230			1 sammanställning			
752 28 Uppsala Fax:018/604282			Material			
All rights reserved Copying prohibited						